

POWER-INA impianto pilota					
FASE			RISCALDA ACQUA		
XCHÉ			Scioglie l' AMIDO		
CA	à	CA	POMPA	OFF	AGITA MAX
Valv.aperte			NN		

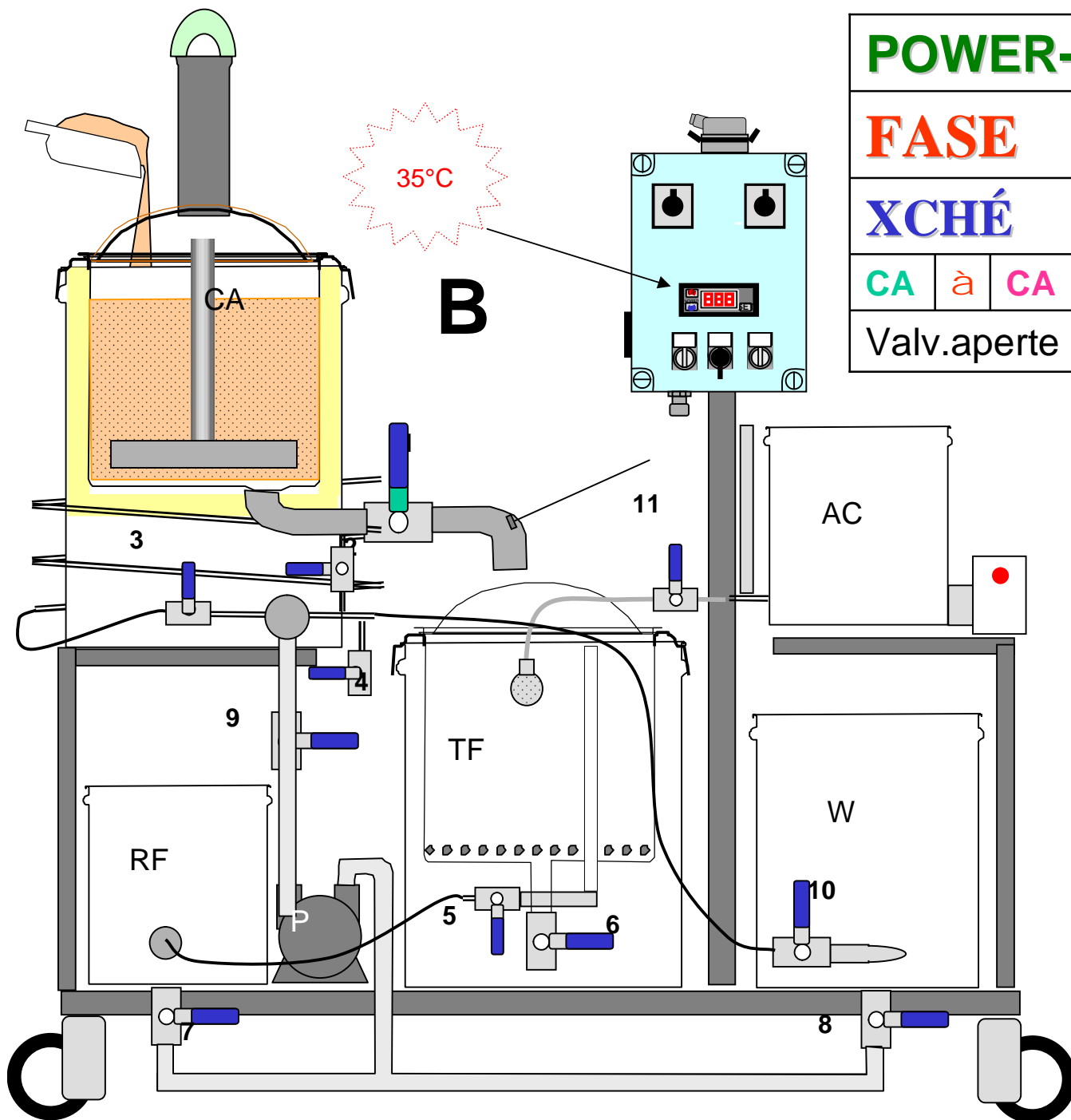

POWER-INA impianto pilota					
FASE			BAGNA il malto		
XCHÉ			Scioglie amido+enzimi		
CA	à	CA	POMPA	OFF	AGITA MAX
Valv.aperte			NN		

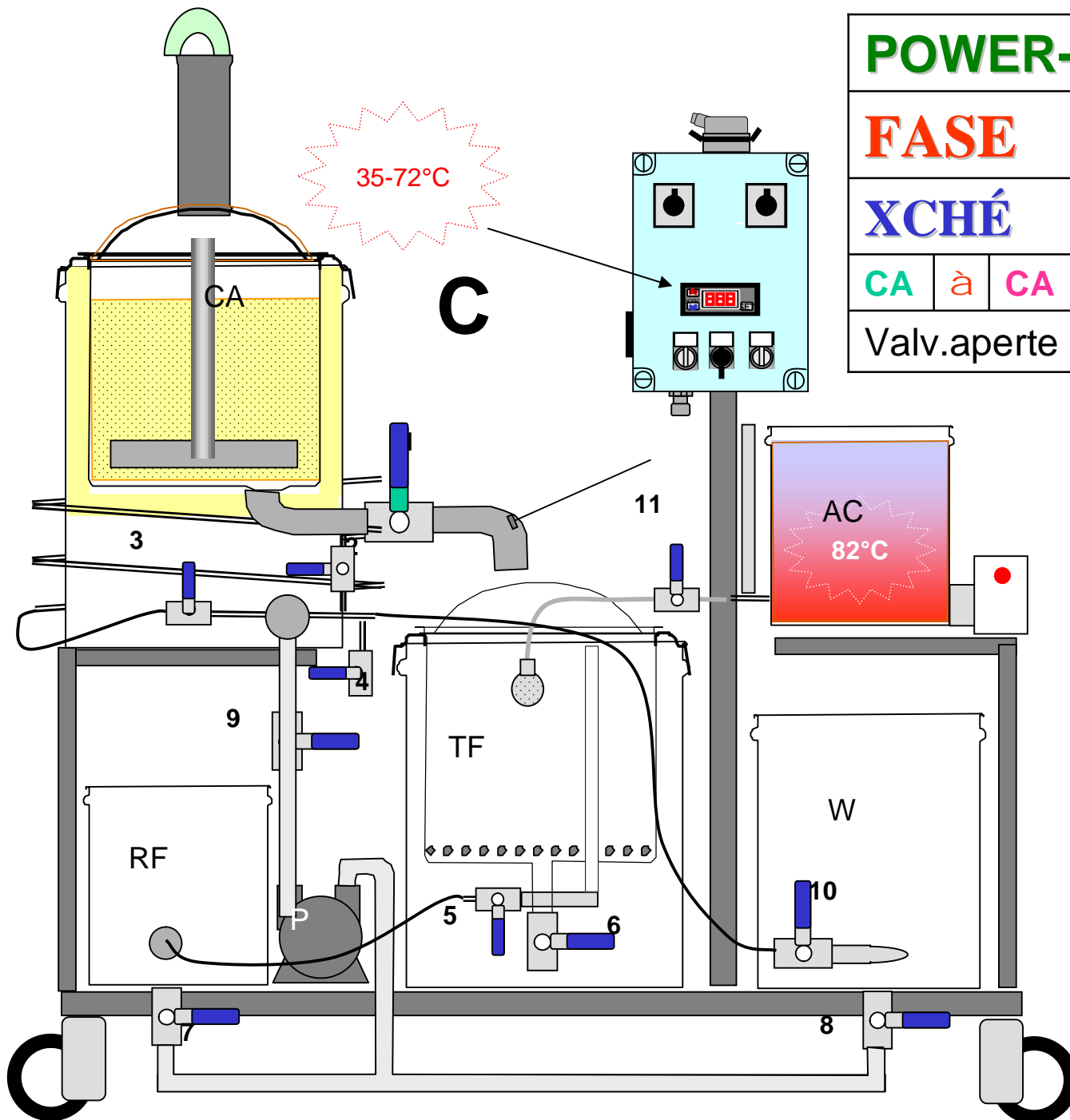

POWER-INA impianto pilota					
FASE			AMMOSTAMENTO		
XCHÉ			AMIDO à zuccheri		
CA	à	CA	POMPA	OFF	AGITA MAX
Valv.aperte			NN		

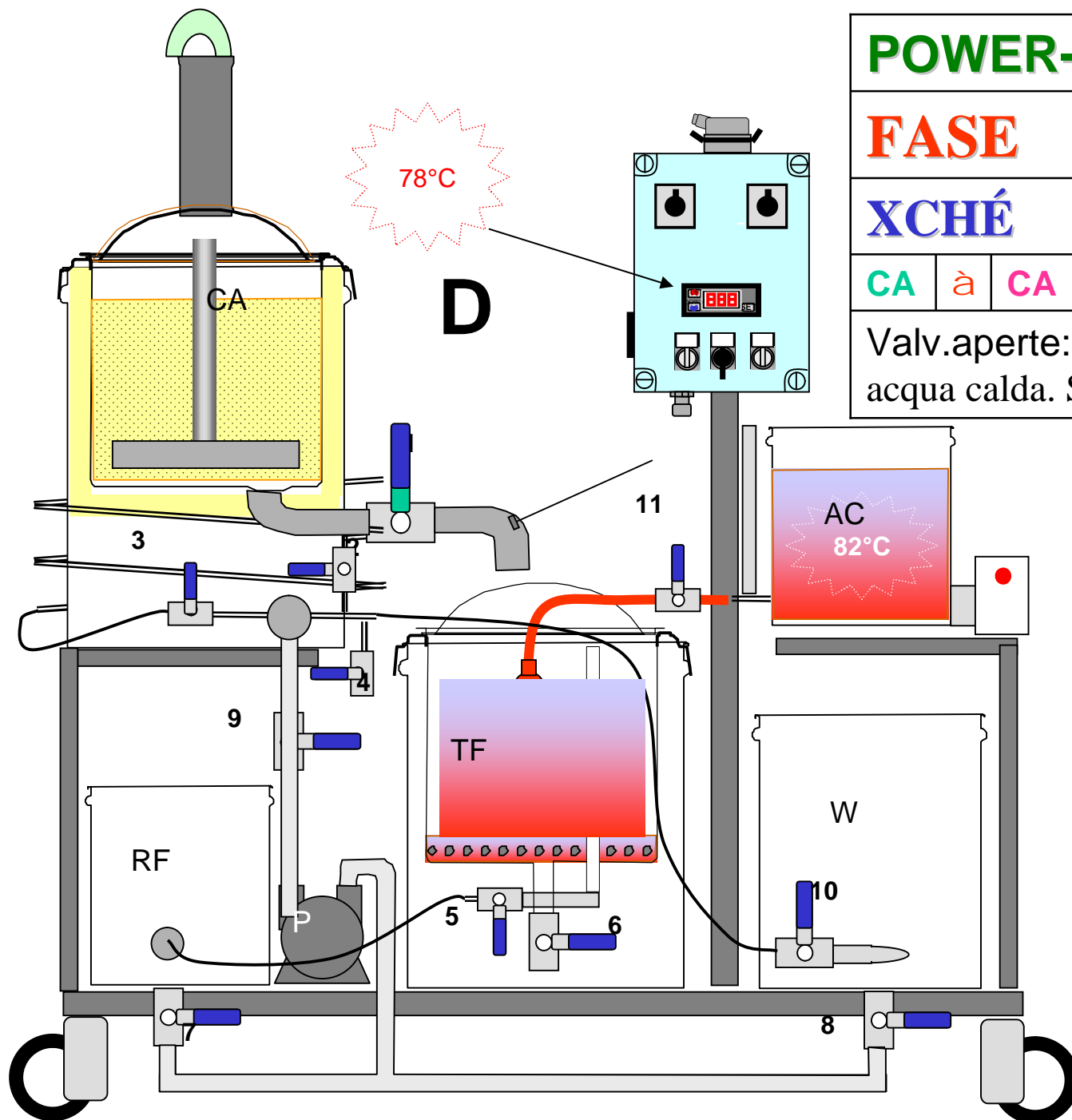

POWER-INA impianto pilota

FASE

FINE AMMOSTAM.

XCHÉ

ferma gli ENZIMI

CA

à

CA

POMPA

OFF

AGITA

MAX

Valv.aperte: n.11 riscalda il tino con 2 litri di acqua calda. Scaricarli prima del travaso!!

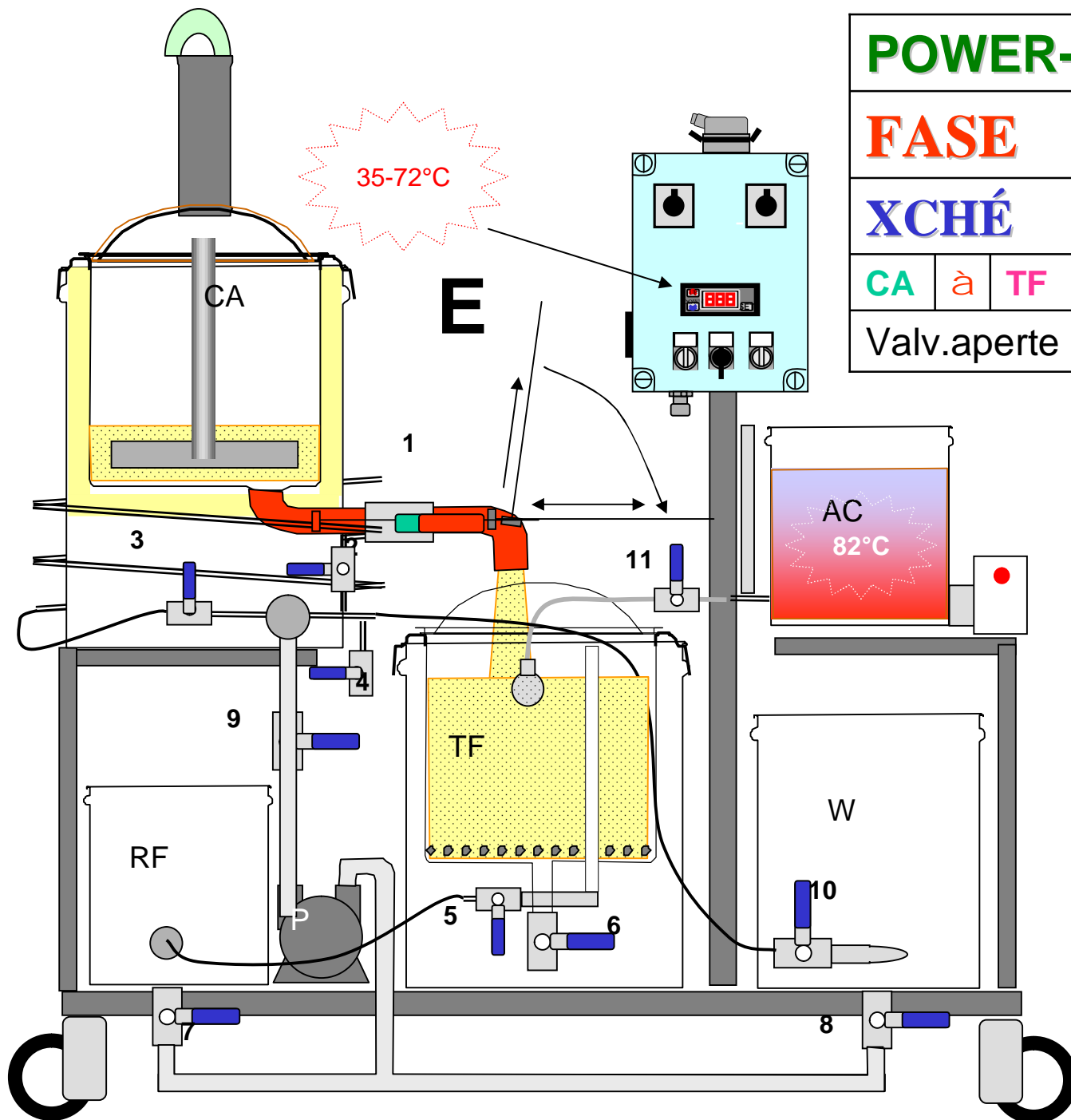

POWER-INA impianto pilota				
FASE		à nel TINO FILTRO		
XCHÉ		SEPARARE I SOLIDI		
CA	à	TF	POMPA	OFF
			AGITA	MAX
Valv.aperte		1		

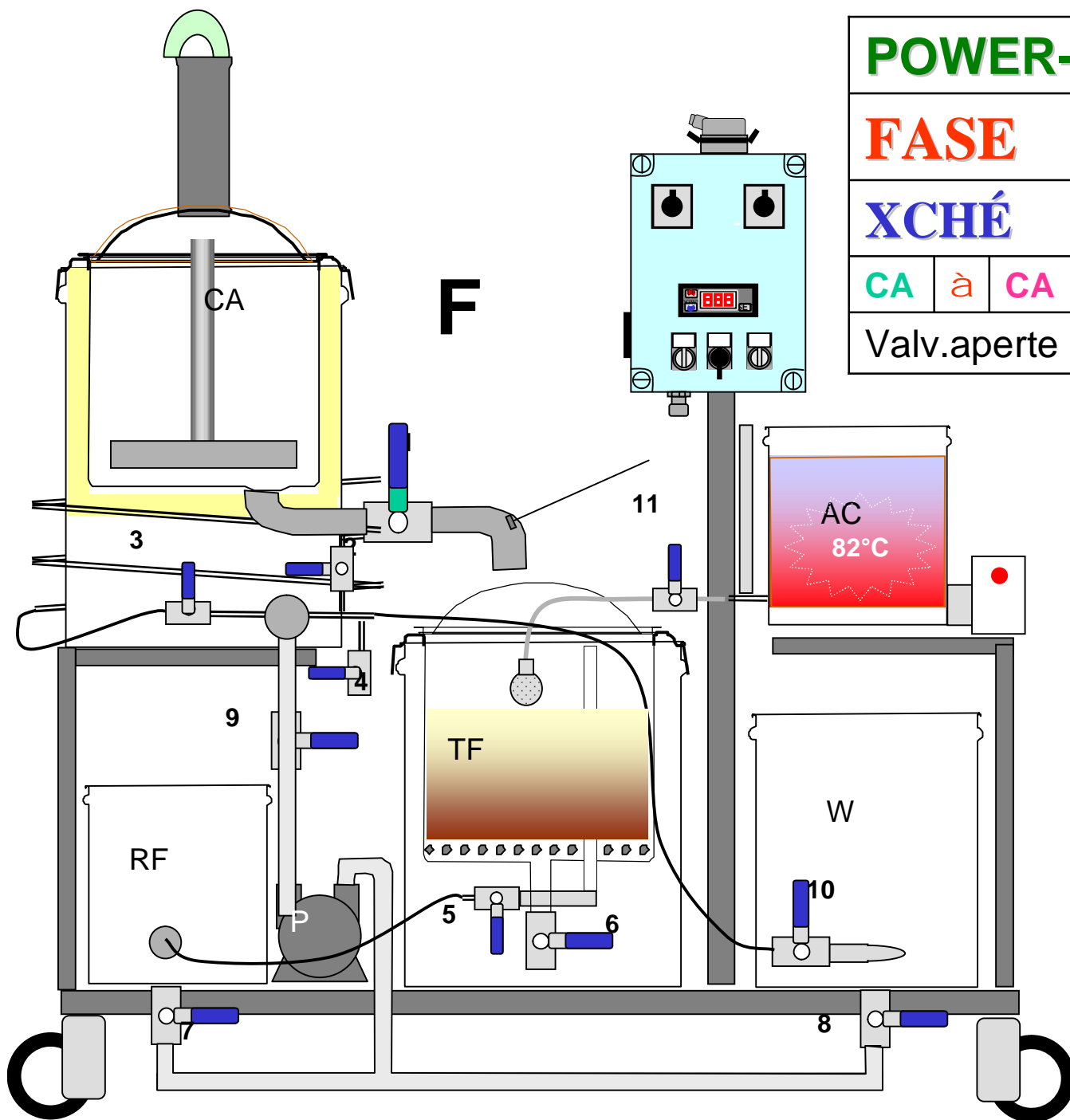

POWER-INA impianto pilota						
FASE			DECANTA TREBBIE			
XCHÉ			Forma il letto Filtrante			
CA	à	CA	POMPA	OFF	AGITA	OFF
Valv.aperte			NN			

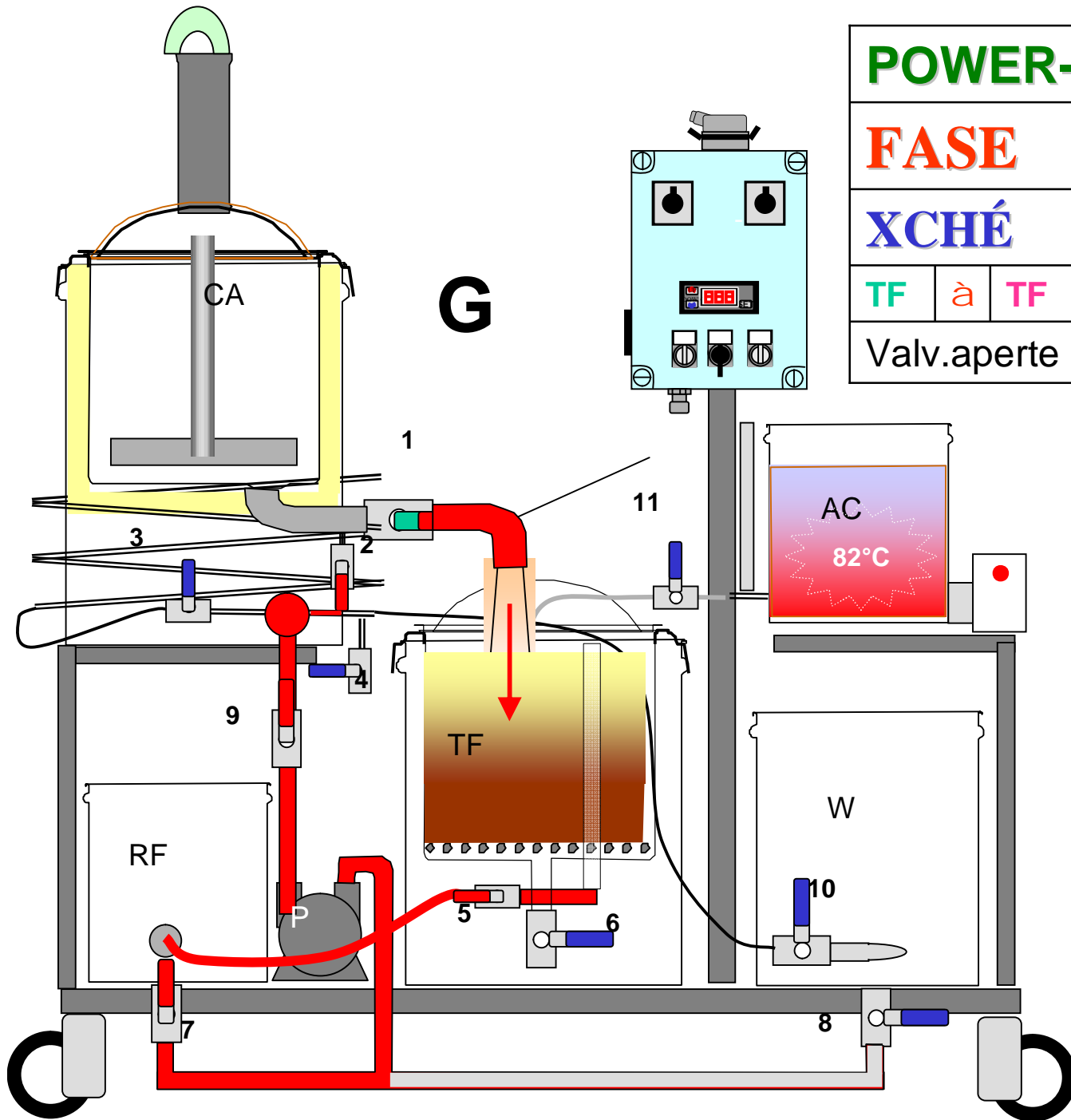

POWER-INA impianto pilota

FASE

Filtra mosto TORBIDO

XCHÉ

Scioglie l' AMIDO

TF à TF

POMPA

ON

AGITA

OFF

Valv.aperte

5,RF,7,P,9,2,1

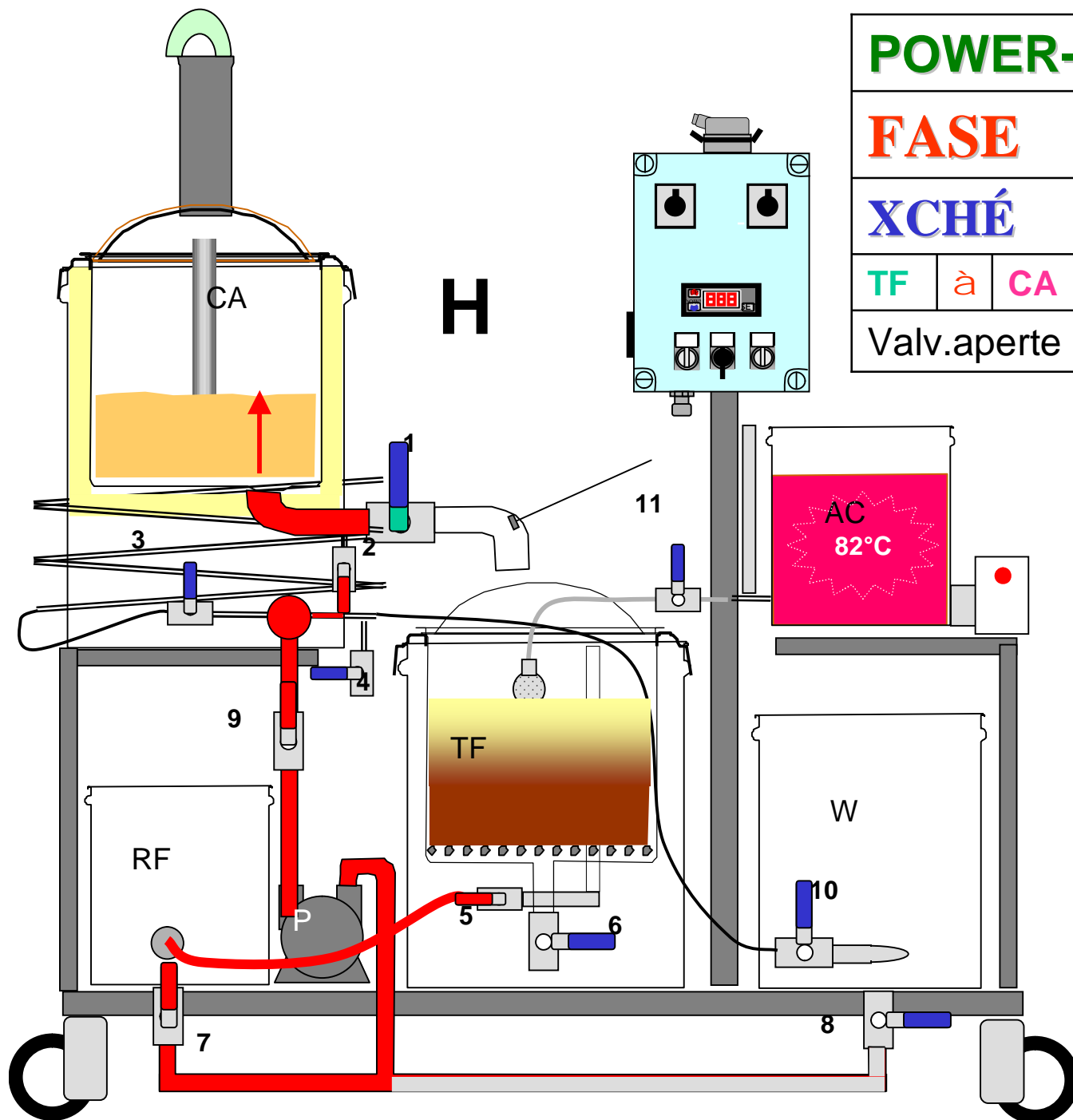

POWER-INA impianto pilota

FASE

Filtra mosto limpido

XCHÉ

Rende limpido il mosto

TF

à

CA

POMPA

ON

AGITA

OFF

Valv.aperte

5,RF,7,P,9,2

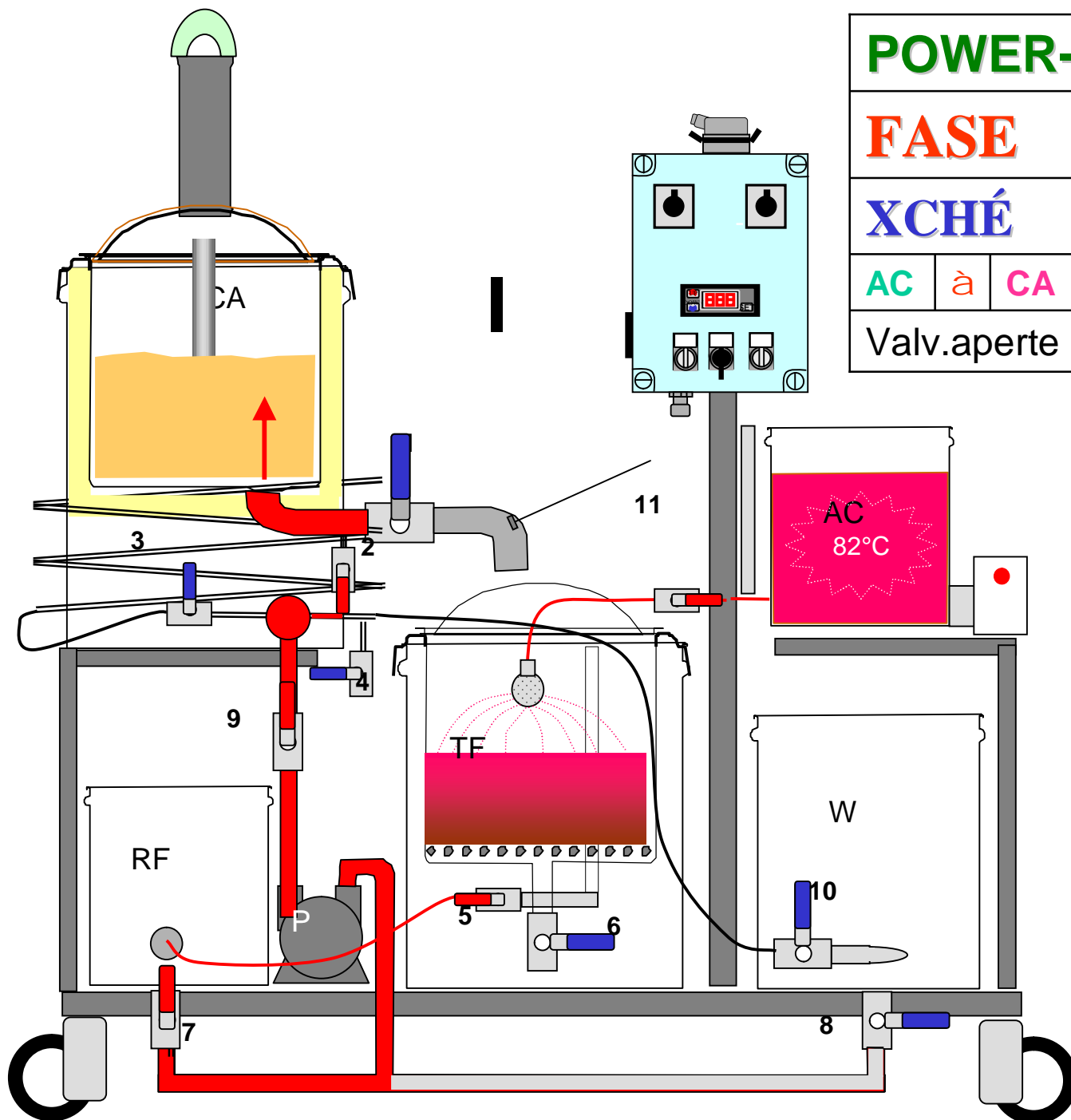

POWER-INA impianto pilota

FASE

LAVAGGIO trebbie

XCHÉ

Recupera zuccheri

AC à **CA**

POMPA

ON

AGITA

OFF

Valv.aperte

11,5,RF,7,9,P,2

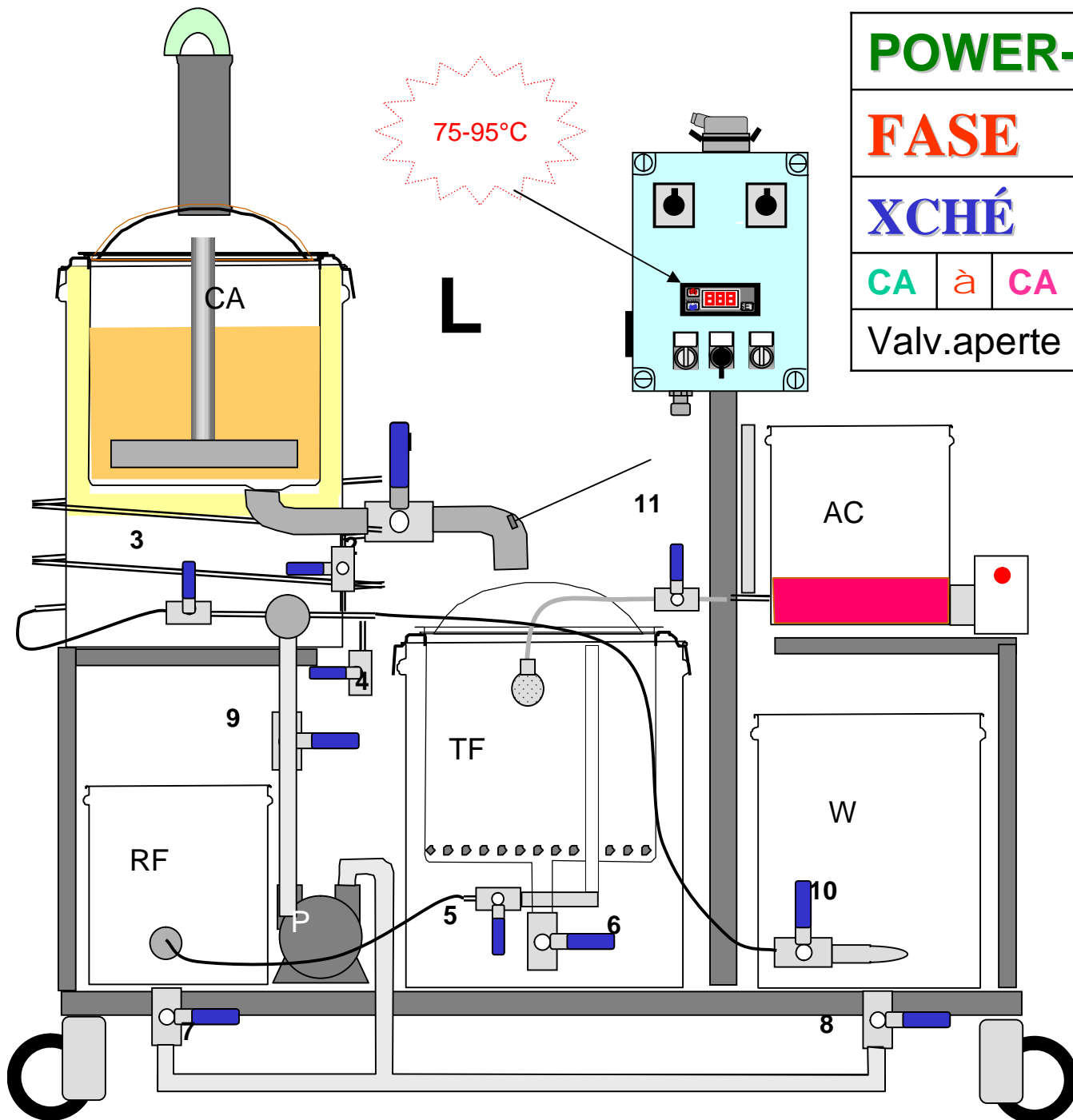

POWER-INA impianto pilota

FASE

RISCALDA MOSTO

XCHÉ

Porta a ebollizione

CA à **CA**

POMPA

OFF

AGITA

LENTO

Valv.aperte

NN

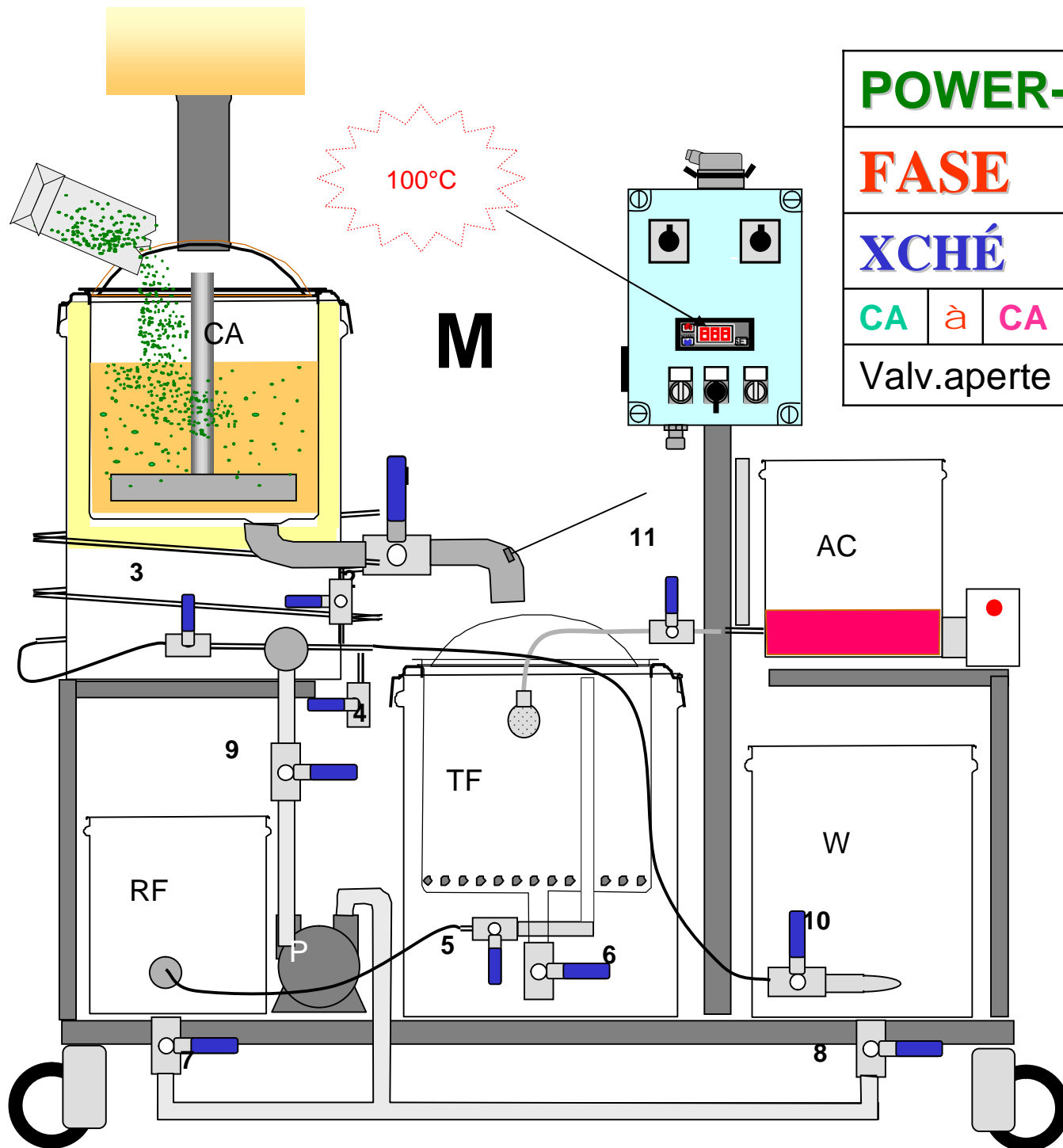

POWER-INA impianto pilota

FASE

BOLLE e LUPPOLA

XCHÉ

Scioglie il luppolo

CA à **CA**

POMPA

OFF

AGITA

LENTO

Valv.aperte

NN

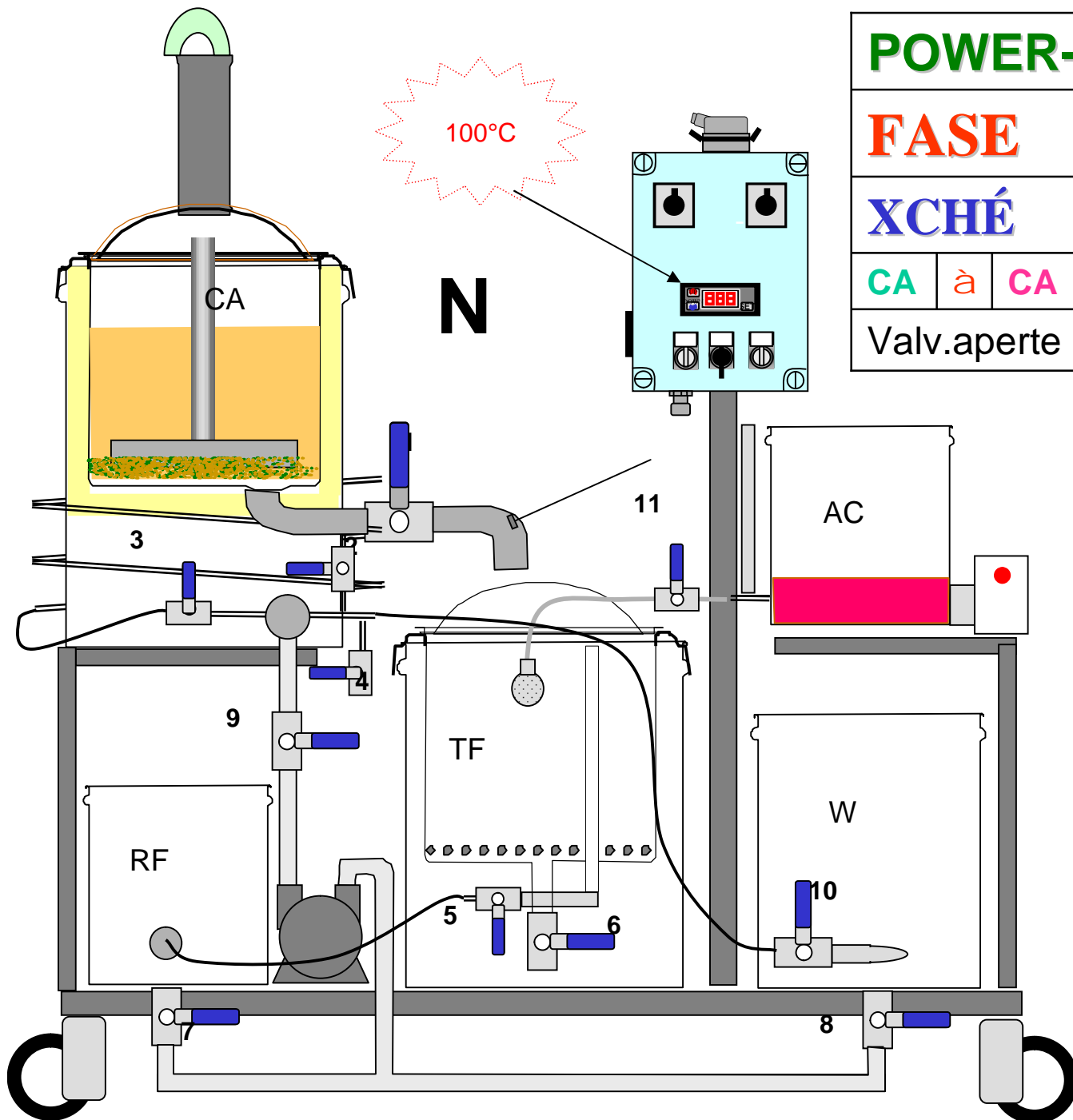

POWER-INA impianto pilota

FASE

DECANTA TRUB

XCHÉ

Separa i **SOLIDI**

CA à CA

POMPA

OFF

AGITA

OFF

Valv.aperte

NN

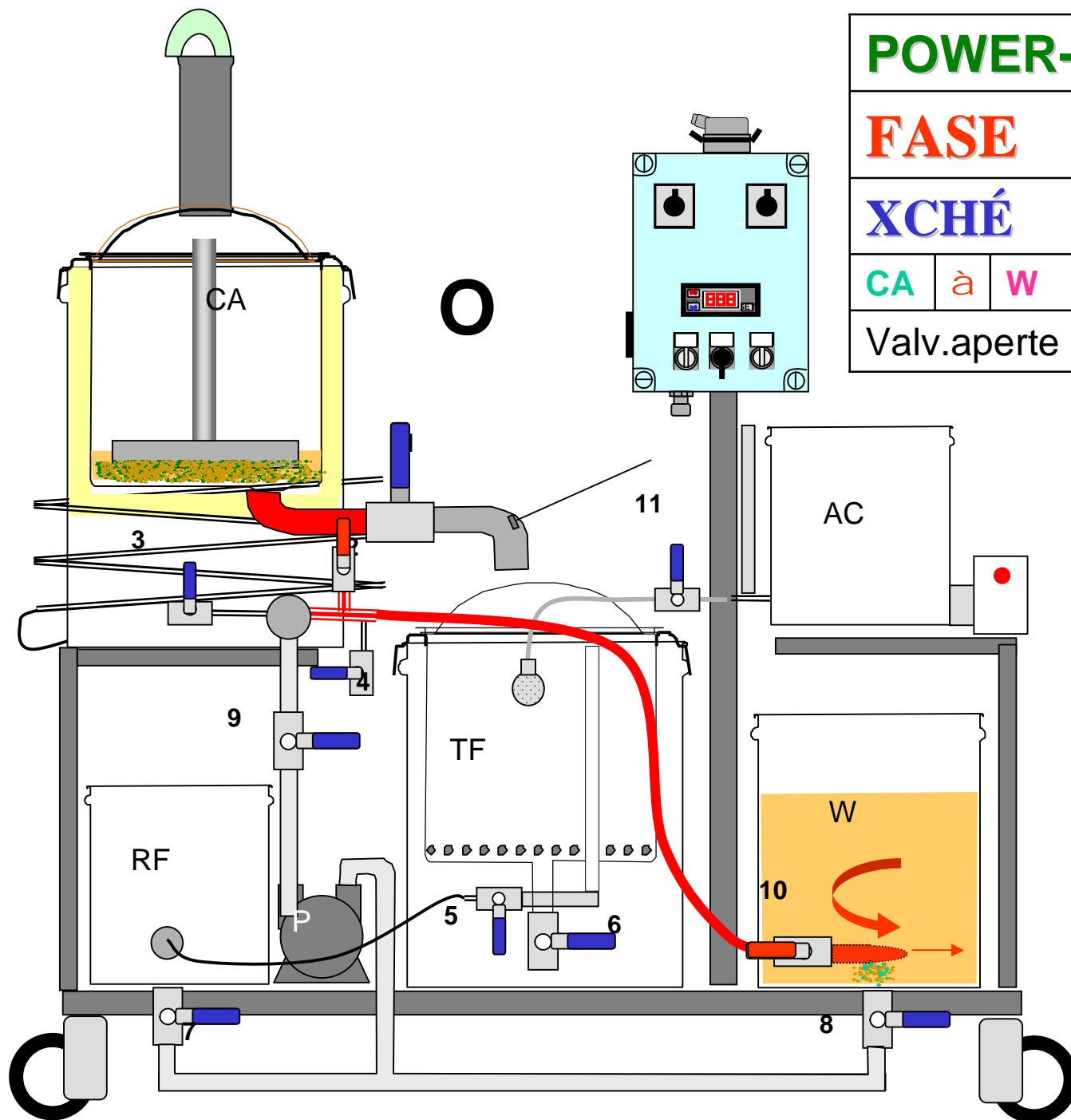

POWER-INA impianto pilota

FASE

à nel whirlpool

XCHÉ

Separa prot. e luppolo

CA

à

W

POMPA

OFF

AGITA

OFF

Valv.aperte

2,10

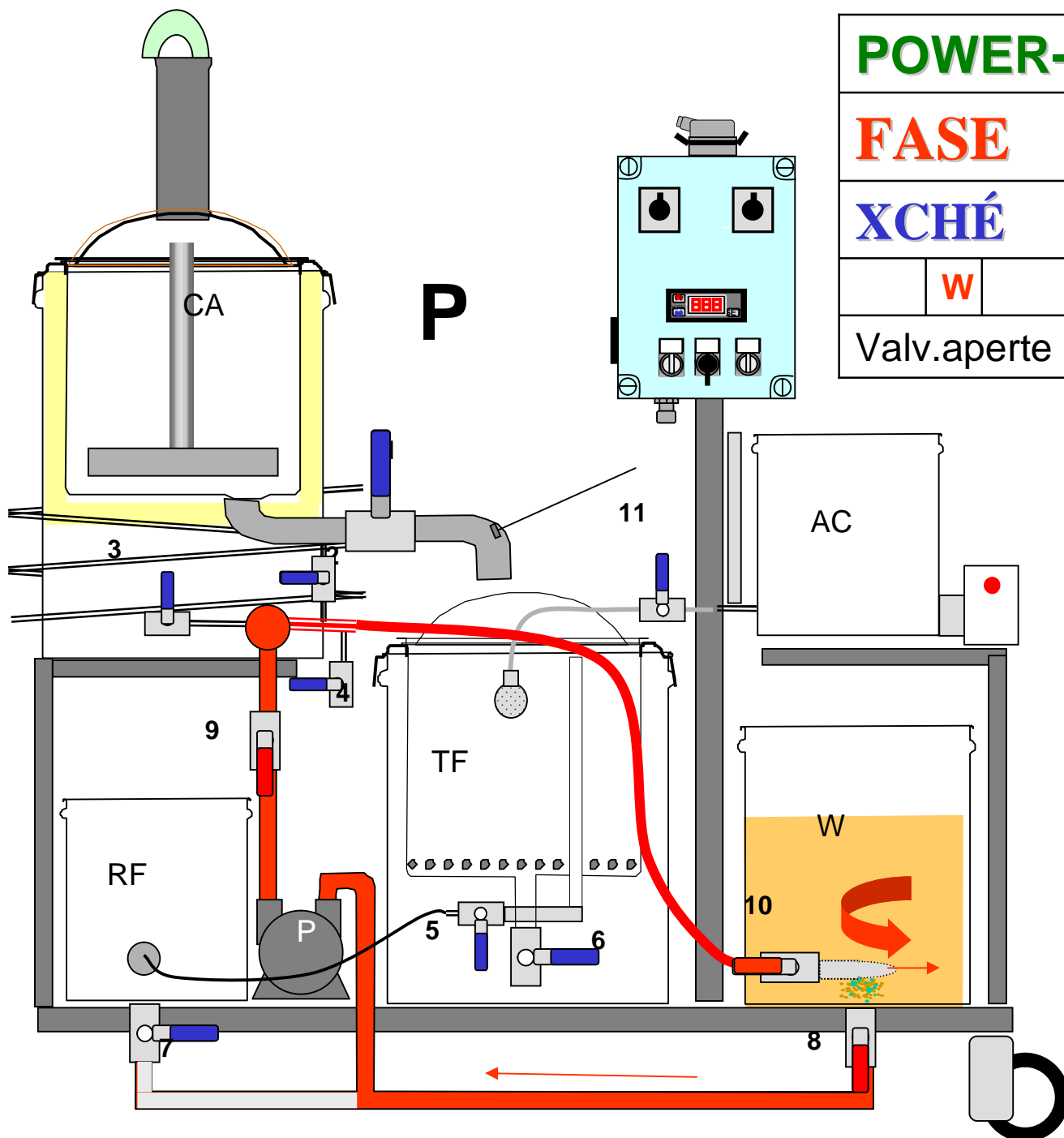

POWER-INA impianto pilota

FASE

FÀ i WHIRLPOOL

XCHÉ

Compatta i solidi

W

POMPA

ON

AGITA

OFF

Valv.aperte

8,9,10

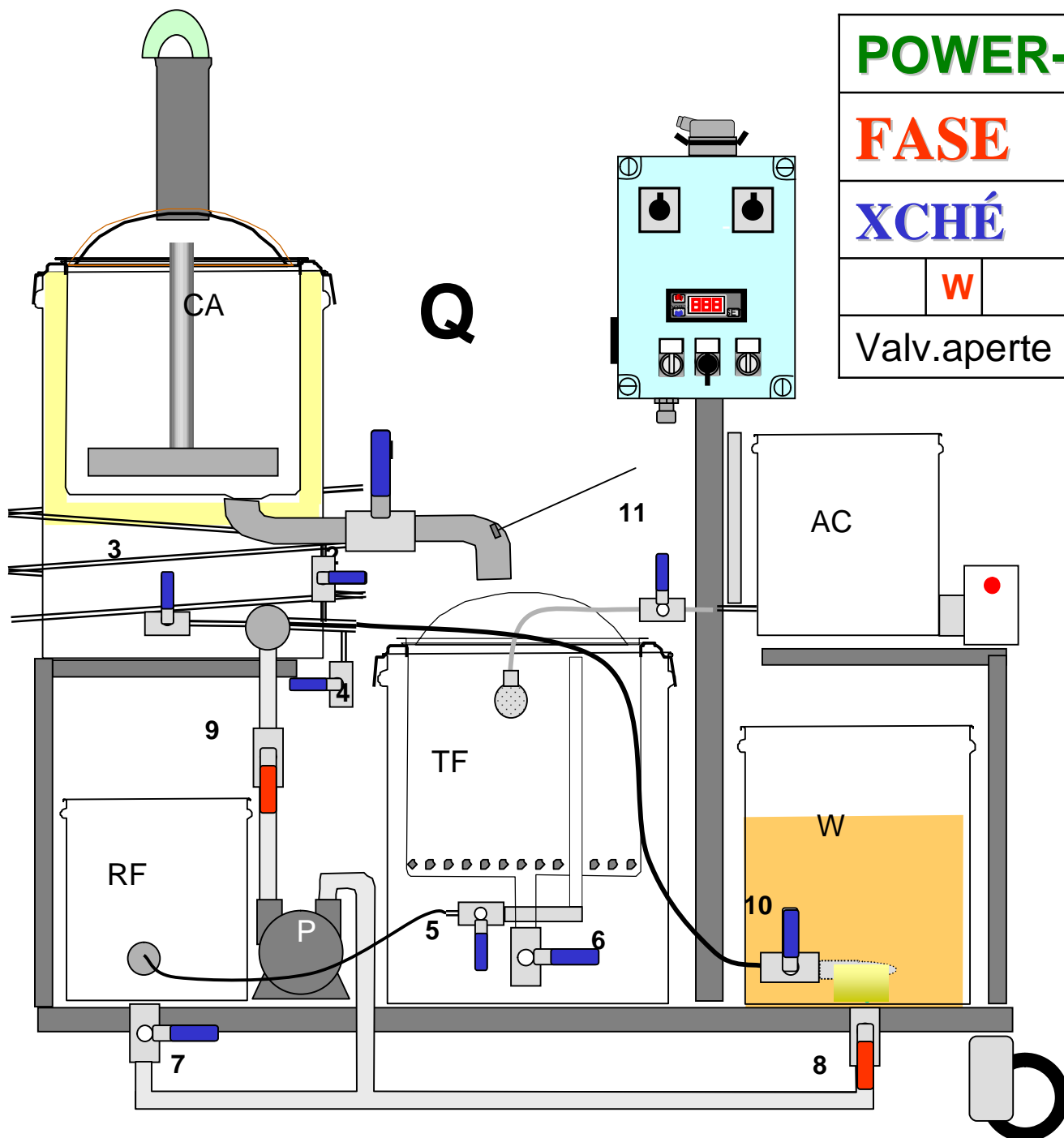

POWER-INA impianto pilota

FASE

STOP WHIRLPOOL

XCHÉ

forma **CONO SOLIDO**

W

POMPA

OFF

AGITA

OFF

Valv.aperte

8,9

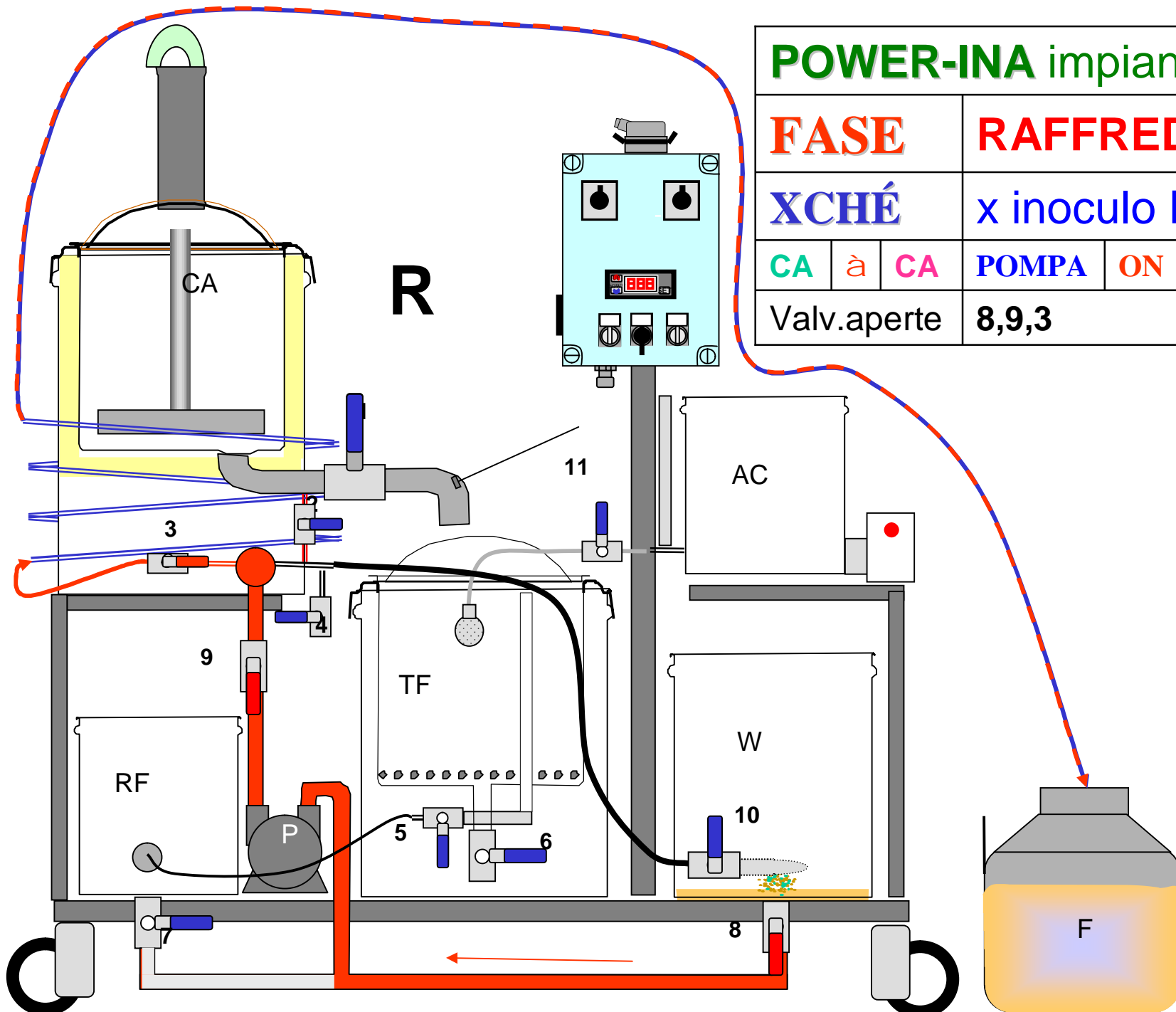

POWER-INA impianto pilota						
FASE			RAFFREDDA mosto			
XCHÉ			x inoculo LIEVITI			
CA	à	CA	POMPA	ON	AGITA	OFF
Valv.aperte			8,9,3			